

IO-540-AF1A5 Operation and Installation Manual

February 2008

FAA Approved

LYCOMING

© 2008

652 Oliver Street
Williamsport, PA 17701

Part No. 60297-33

IO-540-AF1A5 Operation and Installation Manual

Lycoming Part Number: 60297-33

©2008 by Lycoming. All rights reserved.

Lycoming and “Powered by Lycoming” are trademarks or registered trademarks of Lycoming.

Lycoming Engines, a division of AVCO Corporation.

All brand and product names referenced in this publication are trademarks or registered trademarks of their respective companies.

For additional information:

Mailing address:

Lycoming Engines
652 Oliver Street
Williamsport, PA 17701 U.S.A.

Phone:

Factory: 570-323-6181
Sales Department: 570-327-7278
Fax: 570-327-7101

Lycoming’s regular business hours are Monday through Friday from 8:00 A.M. through 5:00 P.M. Eastern Time (-5 GMT)

Visit us on the World Wide Web at:

<http://www.lycoming.com>

LYCOMING OPERATION AND INSTALLATION MANUAL

ATTENTION

OWNERS, OPERATORS, AND MAINTENANCE PERSONNEL

This manual contains a description of the engine, its specifications, and detailed information on how to operate and install it. This manual is FAA Approved and complies with FAR 33.5 and is intended for use by owners, pilots and maintenance personnel responsible for care of Lycoming powered aircraft. Modifications and repair procedures are contained in the Lycoming Maintenance and Overhaul Manual; maintenance personnel must refer to these for such procedures.

SAFETY WARNING

MAINTENANCE MUST BE PERFORMED BY QUALIFIED AND PROPERLY CERTIFIED PERSONNEL. NEGLECTING TO FOLLOW THE OPERATING INSTRUCTIONS AND TO CARRY OUT PERIODIC MAINTENANCE PROCEDURES CAN RESULT IN POOR ENGINE PERFORMANCE AND POWER LOSS. ALSO, IF POWER AND SPEED LIMITATIONS SPECIFIED IN THIS MANUAL ARE EXCEEDED, FOR ANY REASON, DAMAGE TO THE ENGINE AND PERSONAL INJURY CAN HAPPEN. CONSULT YOUR LOCAL FAA APPROVED MAINTENANCE FACILITY.

SERVICE PUBLICATIONS

Lycoming service publications and subscriptions are available through Lycoming distributors or direct from the factory.

NOTE

The illustrations, pictures and drawings shown in this publication are typical of the subject matter they portray; in no instance are they to be interpreted as examples of any specific engine, equipment or part thereof.

LYCOMING OPERATION AND INSTALLATION MANUAL

IMPORTANT SAFETY NOTICE

Proper service and repair is essential to increase the safe, reliable operation of all aircraft engines. The service procedures recommended by Lycoming are effective methods for performing service operations. Some of these service operations require the use of tools specially designed for the task. These special tools must be used when and as recommended.

It is important to note that this manual uses the following Notes, Cautions and Warnings which must be carefully read in order to minimize the risk of personal injury or the use of improper service methods that may damage the engine or render it unsafe.

NOTE

Read for added information and reminders.



CAUTION

Equipment damage may result if instructions are not followed.



WARNING

Personal injury could result if instructions are not followed.

It is also important to understand that these Warnings and Cautions are not all inclusive. Lycoming could not possibly know, evaluate or advise the service trade of all conceivable ways in which service might be done or of the possible hazardous consequences that may be involved. Accordingly, anyone who uses a service procedure must first satisfy themselves thoroughly that neither their safety nor aircraft safety will be jeopardized by the service procedure they select.

LYCOMING OPERATION AND INSTALLATION MANUAL

TABLE OF CONTENTS

		Page
SECTION I	OPERATION	
PART 1	DESCRIPTION	SECTION I, 1-1
PART 2	SPECIFICATIONS	SECTION I, 2-1
PART 3	OPERATING INSTRUCTIONS	SECTION I, 3-1
SECTION II	INSTALLATION	
PART 1	PREPARATION	SECTION II, 1-1
PART 2	PROCEDURES	SECTION II, 2-1

LYCOMING OPERATION AND INSTALLATION MANUAL

This Page Intentionally Left Blank.

SECTION I
OPERATION

This Page Intentionally Left Blank.

LYCOMING OPERATION AND INSTALLATION MANUAL

SECTION I

PART 1 DESCRIPTION

	Page
General	I-1-1
Cylinders	I-1-1
Valve Operating Mechanism	I-1-1
Crankcase	I-1-1
Crankshaft	I-1-1
Accessory Housing	I-1-1
Connecting Rods	I-1-2
Pistons	I-1-2
Oil Sump.....	I-1-2
Cooling System	I-1-2
Induction System	I-1-2
Lubrication System	I-1-3

LYCOMING OPERATION AND INSTALLATION MANUAL

This Page Intentionally Left Blank.

SECTION I

**PART 1
DESCRIPTION**

The Lycoming IO-540-AF1A5 is a fuel injected, direct-drive, six-cylinder, horizontally opposed, and air-cooled with a down exhaust. This engine is supplied with a starter. Mounting pad drives for two AN-type accessories and a propeller governor are included.

FAA Type Certificate Number 1E4 has been issued for this engine.

The IO-540-AF1A5 engine has a rated maximum continuous power of 260 hp at 2700 RPM at standard sea level conditions. The engine has a bore of 5.125 in., a stroke of 4.375 in., a piston displacement of 541.5 cubic inches, and a compression ratio of 8.5:1

Cylinders - The nitrided cylinders are air-cooled with the major parts (head and barrel) screwed and shrunk together. The heads are made from an aluminum alloy casting with a fully machined combustion chamber. Valve guides and valve seats are shrunk into machined recesses in the head. Rocker shaft bearing supports are cast integrally with the head along with the housings to form the rocker boxes for both intake and exhaust valve rockers.

The Lycoming IO-540-AF1A5 engine incorporates a color coding system painted on the cylinder heads to designate the specific cylinder barrels and spark plugs required. The IO-540-AF1A5 engine has nitrided cylinders, indicated by blue paint between the shroud tubes, and requires long-reach spark plugs, indicated by yellow paint between the spark plug and the rocker box cover.

Cylinder barrels are machined from a chrome nickel molybdenum steel forging with deep integral cooling fins. The interiors of the barrels are ground and honed to a specified finish.

Valve Operating Mechanism - The valve-operating mechanism employs a conventional camshaft located above and parallel to the crankshaft. The camshaft actuates tappets which operate the valves through push rods and valve rockers.

Roller tappets are used to compensate for any expansion or contraction occurring in the valve train.

Crankcase - The crankcase assembly consists of two reinforced aluminum alloy castings divided at the centerline of the engine and fastened together by a series of body fit-through studs and bolts and nuts. The mating surfaces of the two castings are joined without use of a gasket, and the main bearing bores are machined for the use of precision-type main bearing inserts. The crankcase forms the bearings for the camshaft.

Crankshaft - The crankshaft is made from a chrome nickel molybdenum steel forging and all journal surfaces are nitrided. A system of dynamic counterweights eliminates torsional vibration.

Accessory Housing - An accessory housing is machined from an aluminum alloy casting and is fastened to the rear of the crankcase and to the top of the oil sump. The two magnetos and the gear-driven fuel pump are mounted on machined pads on the accessory housing, and provisions for two additional accessories are provided.

**SECTION I
DESCRIPTION**

**LYCOMING OPERATION AND INSTALLATION MANUAL
IO-540-AF1A5**

Connecting Rods - Connecting rods are made in the form of “H” sections from alloy steel forgings. They have replaceable bearing inserts in the crankshaft ends and split-type bronze bushings in the piston ends. The bearing caps on the crankshaft ends of the rods are retained by two bolts through each cap secured by nuts.

Pistons - The pistons are machined from an aluminum alloy forging. The piston pin is of the full-floating type with a plug at each end of the pin.

The lubrication system in the IO-540-AF1A5 engine uses a wet sump. Figure 1-1 shows a schematic diagram of the oil system.

Oil Sump - The sump incorporates the usual oil drain plug, oil suction screen, fuel injector mounting pad, and the conventional intake riser and intake pipe connectors.

Cooling System - This engine is designed to be cooled by air pressure. Baffles are provided to build up a pressure and force the air through the cylinder fins. The air is then exhausted to the atmosphere through gills or augments tubes usually located at the rear of the cowling.

Induction System - Lycoming IO-540-AF1A5 engines are equipped with a Precision Airmotive RSA type fuel injection system. The system is based on the principle of measuring air flow and using the air flow signal in a stem type regulator to convert the air force of the air into a corresponding fuel force. This fuel force (fuel pressure differential) applied across the fuel metering section (jet system) makes fuel flow proportional to air flow. A manual mixture control and idle cut-off are provided. Particularly good distribution of the fuel-air mixture is obtained through the center zone induction system, which is integral with the oil sump and is submerged in the oil and aids in cooling the oil in the sump. From the riser, distribution to each cylinder is by individual intake pipes. Fuel vaporization takes place at the intake ports.

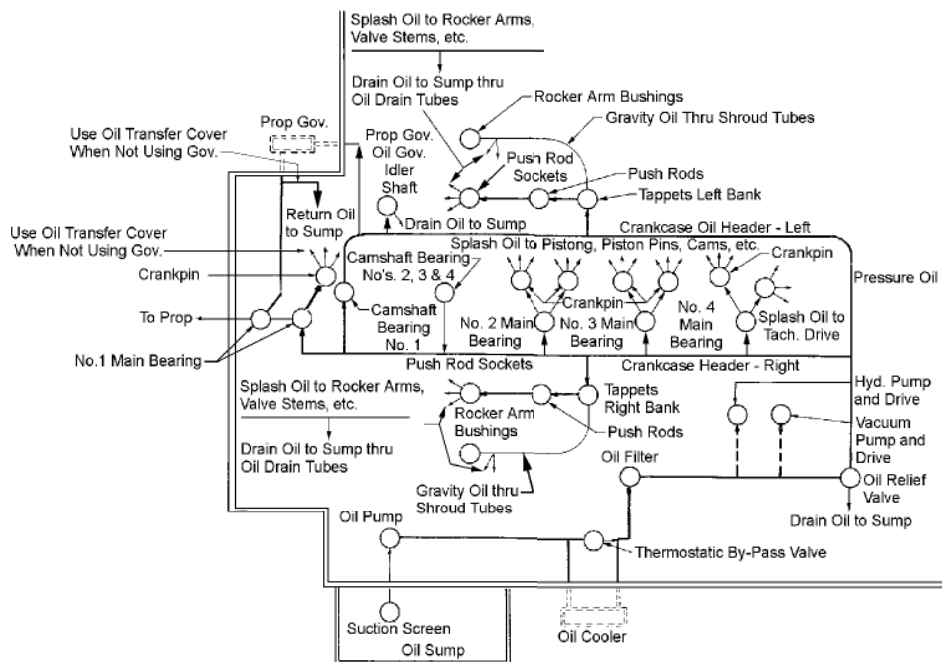

Figure 1-1. Oil System Schematic Diagram

Lubrication System - The lubrication system is of the pressure wet sump type. Figure 1-1 shows a schematic diagram of the oil system. The main bearings, connecting rod bearings, camshaft bearings, valve tappets, push rods and crankshaft idle gears are lubricated by means of oil collectors and spray. The oil pump, which is located in the accessory housing, draws oil through a drilled passage leading from the oil suction screen located in the sump. The oil from the pump then enters a drilled passage in the accessory housing, where a flexible line leads the oil to the external oil cooler. In the event that cold oil or an obstruction should restrict the flow of oil to the cooler, an oil cooler bypass valve is provided. Pressure oil from the cooler returns to a second threaded connection on the accessory housing from which point a drilled passage conducts the oil to the oil pressure screen, which is installed in a cast chamber located on the accessory housing below the tachometer drive.

The oil pressure screen is provided to filter from the oil any solid particles that may have passed through the suction screen in the sump. After being filtered in the pressure screen chamber, the oil is fed through a drilled passage to the oil relief valve, located in the upper right side of the crankcase in the front of the accessory housing.

This relief valve regulates the engine oil pressure by allowing excessive oil to return to the sump, while the balance of the pressure oil is fed to the main oil gallery, the oil is distributed by means of separate drilled passages to the main bearings of the rod journals. Oil from the main oil gallery also flows to the cam and the valve gear passages, and is then conducted through branch passages to the roller tappets and camshaft bearings. Oil enters the tappet through indexing holes and travels out through the hollow push rods to the valve mechanism, lubricating the valve rocker bearings and the valve stems. Residual oil from the bearings, accessory drives and the rocker boxes is returned by gravity to the sump.

The fuel injection systems control fuel flow in proportion to airflow with injection.

Dual ignition is furnished by two Slick magnetos and harnesses.

This Page Intentionally Left Blank.

LYCOMING OPERATION AND INSTALLATION MANUAL

SECTION I

PART 2 SPECIFICATIONS

	Page
Specifications.....	I-2-1
Standard Engine Weights	I-2-1
Moments of Inertia	I-2-1
Accessory Drives	I-2-1

LYCOMING OPERATION AND INSTALLATION MANUAL

This Page Intentionally Left Blank.

SECTION I

PART 2

1. SPECIFICATIONS.

Model Designation.....	IO-540-AF1A5
FAA Type Certificate	1E4
Rated horsepower	260
Rated speed, RPM	2700
Bore, inches	5.125
Stroke, inches	4.375
Displacement, cubic inches	541.5
Compression ratio	8.5:1
Firing order	1-4-5-2-3-6
Spark occurs, degrees BTC	25°
Valve rocker clearance (hydraulic tappets collapsed)028-.080
Prop. drive ratio	1:1
Prop. driven rotation	Clockwise

2. Standard Engine, Dry Weight (Includes all engine accessories except alternator.)

IO-540-AF1A5	415 lbs.
--------------------	----------

3. Moments of Inertia (Standard Dry Weight, all)

About the axis parallel to the crankshaft centerline (I _{xg})	66.48 in. lb. sec ²
About the vertical axis (I _{zg})	118.87 in. lb. sec ²
About the axis parallel to the centerline (I _{yg})	80.68 in. lb. sec ²

4. Accessory Drives

*Accessory Drive	Drive Ratio	**Direction of Rotation
Starter	16.556:1	Counter-Clockwise
Alternator	3.200:1	Clockwise
Vacuum Pump	1.300:1	Counter-Clockwise
Hydraulic Pump	1.385:1	Clockwise
Tachometer	.500:1	Clockwise
Propeller Governor	.947:1	Clockwise
Magneto Drive	1.500:1	Clockwise
Fuel Pump - AN (Gear Driven)	1.000:1	Counter-Clockwise

* - When applicable.

** - Viewed facing drive pad.

This Page Intentionally Left Blank.

LYCOMING OPERATION AND INSTALLATION MANUAL

SECTION I

PART 3 OPERATING INSTRUCTIONS

	Page
General	I-3-1
Prestarting Items of Maintenance	I-3-1
Starting Procedures	I-3-2
Cold Weather Starting	I-3-3
Ground Running and Warm-Up	I-3-3
Ground Check	I-3-3
Operating in Flight	I-3-4
Fuel Mixture Leaning Procedure	I-3-4
Engine Flight Chart	I-3-5
Engine Shut Down	I-3-6
Performance Curves	I-3-7

LYCOMING OPERATION AND INSTALLATION MANUAL

This Page Intentionally Left Blank.

SECTION I

PART 3

1. GENERAL.

Close adherence to these instructions will greatly contribute to the long life, economy and satisfactory operation of the engine.

NOTE

YOUR ATTENTION IS DIRECTED TO THE WARRANTIES THAT APPEAR IN THE FRONT OF THIS MANUAL REGARDING ENGINE SPEED, THE USE OF SPECIFIED FUELS AND LUBRICANTS, REPAIRS AND ALTERATIONS. PERHAPS NO OTHER ITEM OF ENGINE OPERATION AND MAINTENANCE CONTRIBUTES QUITE SO MUCH TO SATISFACTORY PERFORMANCE AND LONG LIFE AS THE CONSTANT USE OF CORRECT GRADES OF FUEL AND OIL, CORRECT ENGINE TIMING, AND FLYING THE AIRCRAFT AT ALL TIMES WITHIN THE SPEED AND POWER RANGE SPECIFIED FOR THE ENGINE. DO NOT FORGET THAT VIOLATION OF THE OPERATION AND MAINTENANCE SPECIFICATIONS FOR YOUR ENGINE WILL NOT ONLY VOID YOUR WARRANTY BUT WILL SHORTEN THE LIFE OF YOUR ENGINE AFTER ITS WARRANTY PERIOD HAS PASSED.

New engines have been carefully run-in by Lycoming and therefore, no further break-in is necessary insofar as operation is concerned; however, operate new or newly overhauled engines using only the recommended lubricating oils. Refer to Oil Requirements, Section 8.d.

NOTE

Cruise at 65% to 75% power until a total of 50 hours has been accumulated or the oil consumption has stabilized. This is to insure the proper seating of the rings as is applicable to new engines and engines in service following cylinder replacement or top overhaul of one or more cylinders.

The minimum fuel octane rating is listed in the flight chart, Part 9 of this section. Do not use fuel of a lower octane rating or automotive fuel (regardless of octane rating).

2. PRESTARTING ITEMS OF MAINTENANCE.

Before starting the aircraft engines for the first flight of the day, perform the following items of maintenance inspection in conjunction with the aircraft Pilot's Operating Handbook preflight check.

- (a) Be sure all switches are in the "Off" position.
- (b) Be sure magneto ground wires are connected.
- (c) Check oil level.

- (d) Check fuel level.
- (e) Check fuel and oil line connections, note minor indications for repair at 50 hour inspection. Repair any leaks before aircraft is flown.
- (f) Open the fuel drain to remove any accumulation of water and sediment.
- (g) Make sure all shields and cowling are in place and secure. If any are missing or damaged, repair or replacement should be made before the aircraft is flown.
- (h) Check engine controls for general condition, travel and freedom of operation.
- (i) Inspect and service Induction system air filter in accordance with the airframe manufacturer's recommendations.

3 STARTING PROCEDURES.

The following starting procedures are recommended; however, the starting characteristics of various installations will necessitate some variation from these procedures.

NOTE

Limit cranking periods to ten (10) to twelve (12) seconds with 5 minutes rest between cranking periods.

- (a) *Cold Engine.*
 - (1) Perform pre-flight inspection.
 - (2) Set propeller governor in "Full RPM".
 - (3) Turn fuel valve to "on" position.
 - (4) Open throttle approximately ¼ inch travel.
 - (5) Turn boost pump on and move mixture control to "Full Rich" position until a slight but steady flow is indicated.
 - (6) Return mixture control to "Idle Cut-Off" position.
 - (7) Set magneto selector switch. Consult aircraft manufacturer's handbook for correct position.
 - (8) Engage starter.
 - (9) When engine starts, place magneto selector switch in "Both" position.
 - (10) Move mixture control slowly and smoothly to "Full Rich".
 - (11) Check oil pressure gage for indicated pressure. If oil pressure is not indicated within thirty seconds, stop the engine and determine trouble.

NOTE

If engine fails to achieve a normal start, assume it to be flooded. Crank engine over with throttle wide open and ignition off. Then repeat above procedure.

Hot Engine - Because fuel percolates, the system must be cleared of vapor; it is recommended that the same procedure, as outlined above be used for starting a hot engine.

4. COLD WEATHER STARTING.

During extreme cold weather, it may be necessary to preheat the engine and oil before starting.

5. GROUND RUNNING AND WARM-UP.

Subject engines are air pressure cooled and depend on the forward movement of the aircraft to maintain proper cooling. Particular care is necessary, therefore, when operating these engines on the ground. To prevent overheating, it is recommended that the following precautions be observed.

NOTE

Any ground check that requires full throttle operation must be limited to three minutes, or less if indicated cylinder head temperature should exceed the maximum stated in this manual.

- (a) Head the aircraft into the wind.
- (b) Leave mixture in "Full Rich".
- (c) Operate the engine on the ground only with the propeller in minimum blade angle setting.
- (d) Warm up at approximately 1000-1200 RPM. Avoid prolonged idling and do not exceed 2200 RPM on the ground.
- (e) Engine is warm enough for take-off when the throttle can be opened without the engine faltering.

6. GROUND CHECK.

- (a) Warm up as directed above.
- (b) Check both oil pressure and oil temperature.
- (c) Leave mixture in "Full Rich".
- (d) (Where applicable) Move the propeller control through its complete range to check operation and return to full low pitch position. Full feathering check (twin engine) on the ground is not recommended but the feathering action can be checked by running the engine between 1000-1500 RPM; then momentarily pulling the propeller control into the feathering position. Do not allow the RPM to drop more than 500 RPM.
- (e) A proper magneto check is important. Additional factors, other than the ignition system, affect magneto drop-off. They are load-power output, propeller pitch and mixture strength. The important thing is that the engine runs smoothly because magneto drop-off is affected by the variables listed above. Make the magneto check in accordance with the following procedures.

- (1) (Controllable Pitch Propeller) With propeller in minimum pitch angle, set the engine to produce 50-65% power as indicated by the manifold pressure gage. Mixture control should be in the full rich position. At these settings, the ignition system and spark plugs must work harder because of the greater pressure within the cylinders. Under these conditions, ignition problems can occur. Mag checks at low power settings will only indicate fuel-air distribution quality.

NOTE

Aircraft that are equipped with fixed pitch propellers, or not equipped with manifold pressure gage, may check magneto drop-off with engine operating at approximately 2100-2200 RPM.

- (2) Switch from both magnetos to one and note drop-off; return to both until engine regains speed and switch to the other magneto and note drop-off, then return to both. Drop-off should not exceed 175 RPM and should not exceed 50 RPM between magnetos. A smooth drop-off past normal is usually a sign of a too lean or too rich mixture.
- (f) Do not operate on a single magneto for too long a period; a few seconds is usually sufficient to check drop-off and will minimize plug fouling.

7. *OPERATING IN FLIGHT.*

- (a) Subject engines are equipped with a dynamic counterweight system and must be operated accordingly. Use a smooth, steady movement (avoid rapid opening and closing) of the throttle.
- (b) See airframe manufacturer's instructions for recommended power settings.

8. *FUEL MIXTURE LEANING PROCEDURE.*

Improper fuel/air mixture during flight is responsible for many engine problems, particularly during take-off and climb power settings. The procedures described in this manual provide proper fuel/air mixture when leaning Lycoming engines; they have proven to be both economical and practical by eliminating excessive fuel consumption and reducing damaged parts replacement. It is therefore recommended that operators, of all Lycoming aircraft power-plants, utilize the instructions in this publication any time the fuel/air mixture is adjusted during flight.

Manual leaning may be monitored by exhaust gas temperature indication, fuel flow indication, and by observation of engine speed and/or airspeed. However, whatever instruments are used in leaning the mixture, observe the following general rules.

GENERAL LEANING RULES

Never exceed the maximum red line cylinder head temperature limit.

For maximum service life, cylinder head temperatures must be maintained below 435°F. (224°C.) during high performance cruise operation and below 400°F. (205°C.) for economy cruise powers.

On engines with manual mixture control, maintain mixture control in “Full Rich” position for rated take-off, climb and maximum cruise powers (above approximately 75%). However, during take-off from high elevation airport or during climb, roughness or loss of power may result from over-richness. In such a case adjust mixture control only enough to obtain smooth operation - not for economy. Observe instruments for temperature rise. Rough operation due to over-rich fuel/air mixture is most likely to be encountered at altitudes above 5,000 feet.

Always return the mixture to full rich before increasing power settings.

Operate the engine at maximum power mixture for performance cruise powers and at best economy mixture for economy cruise power; unless otherwise specified in the airplane owners manual.

During let-down flight operations it may be necessary to manually lean carbureted or fuel injected engines to obtain smooth operation.

(a) Leaning to Exhaust Gas Temperature.

(Normally aspirated engines with fuel injectors or carburetors)

(1) Maximum Power Cruise (approximately 75% power) - Never lean beyond 150°F. on rich side of peak EGT unless aircraft operator’s manual shows otherwise. Monitor cylinder head temperatures.

(2) Best Economy Cruise (approximately 75% power and below) - Operate at peak EGT.

(b) Leaning to Flowmeter.

Lean to applicable fuel-flow tables or lean to indicator marked for correct fuel-flow for each power setting.

9. ENGINE FLIGHT CHART.

(a) Fuel Requirements.

91/96 Octane, Minimum Aviation Grade Fuel

(b) Fuel Pressure, psi	Min.	Max.	Idle Min.
Inlet to fuel pump	-2	35	
Inlet to fuel injector	14	45	12

**SECTION I
OPERATING INSTRUCTIONS**

**LYCOMING OPERATION AND INSTALLATION MANUAL
IO-540-AF1A5**

(c) Oil Requirements

Average Ambient Air	*Recommended Grade Oil	
	MIL-L-6082B or SAEJ1966 Spec. Mineral Grades Grades	MIL-L-22851 or SAEJ1899 Spec. Ashless Dispersant Grades
All Temperatures	---	SAE15W50 or SAE20W-50
Above 80°F.	SAE 60	SAE60
Above 60°F.	SAE 50	SAE40 or SAE50
30°F. to 90°F.	SAE 40	SAE40
0°F. to 70°F.	SAE 30	SAE40, SAE30, SAE20W40
0°F. to 90°F	SAE20W50	SAE20W50 or SAE15W50
Below 10°F.	SAE 20	SAE30 or SAE20W-30

* - In new, newly overhauled, or rebuilt engines or following the replacement of one or more cylinders, use only mineral oil during the first 50 hours of operation.

(d) Oil Sump Capacity

IO-540-AF1A5	8 U.S. Qts.
(Minimum safe quantity in sump)	2 U.S. Qts.

<i>(e) Oil Pressure, psi</i>	Maximum	Minimum	Idling	Start and Warm-up
Normal Operation	95	55	25	115

(f) Oil Temperature: The maximum permissible oil temperature is 245°F. (118°C.). For maximum engine life, maintain desired oil temperature between 165°F. (73.8°C.) and 200°F. (93.3°C.) in level-flight cruise conditions.

(g) Fuel and Oil Consumption

Operation	RPM	HP	Fuel Cons. Gal/Hr.	Max. Oil Cons. Qts./Hr.	*Max. Cyl. Head Temp.
Normal Rated	2700	260	---	1.0	475°F. (246°C.)
Performance Cruise (75% Rated)	2450	195	15.0	0.75	475°F. (246°C.)
Economy Cruise (60% Rated)	2350	155	12.5	0.60	475°F. (246°C.)

* - At Bayonet Location - For maximum service life of the engine maintain cylinder head temperatures between 150°F. and 435°F. during continuous operation.

10. ENGINE SHUT DOWN.

- (a) Set propeller at minimum blade angle.
- (b) Idle until there is a decided decrease in cylinder head temperature.
- (c) Move mixture control to "Idle Cut-Off".
- (d) When engine stops, turn ignition switch off.

FUEL FLOW VS NOZZLE PRESSURE

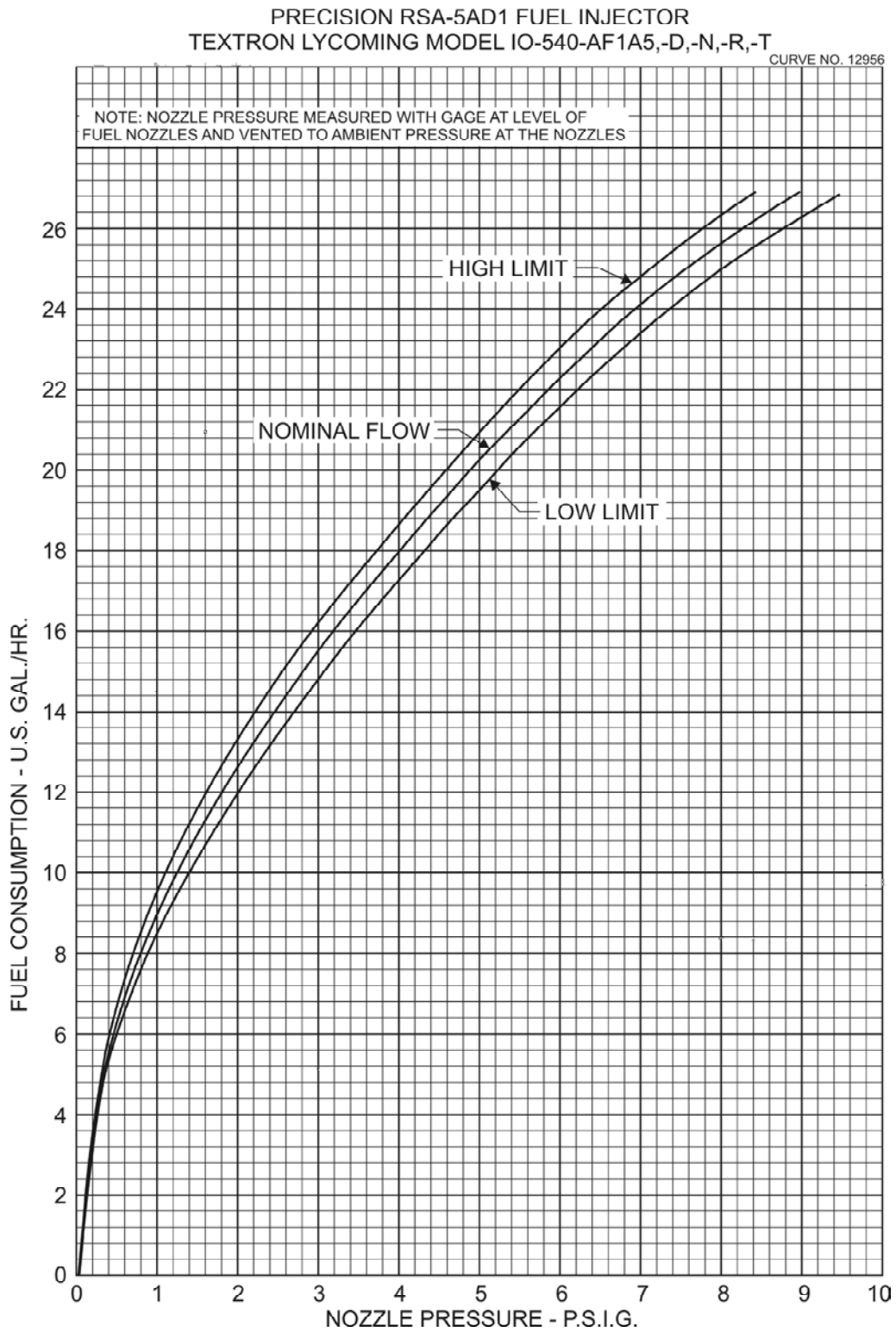

Figure 3-1. Part Throttle Fuel Consumption

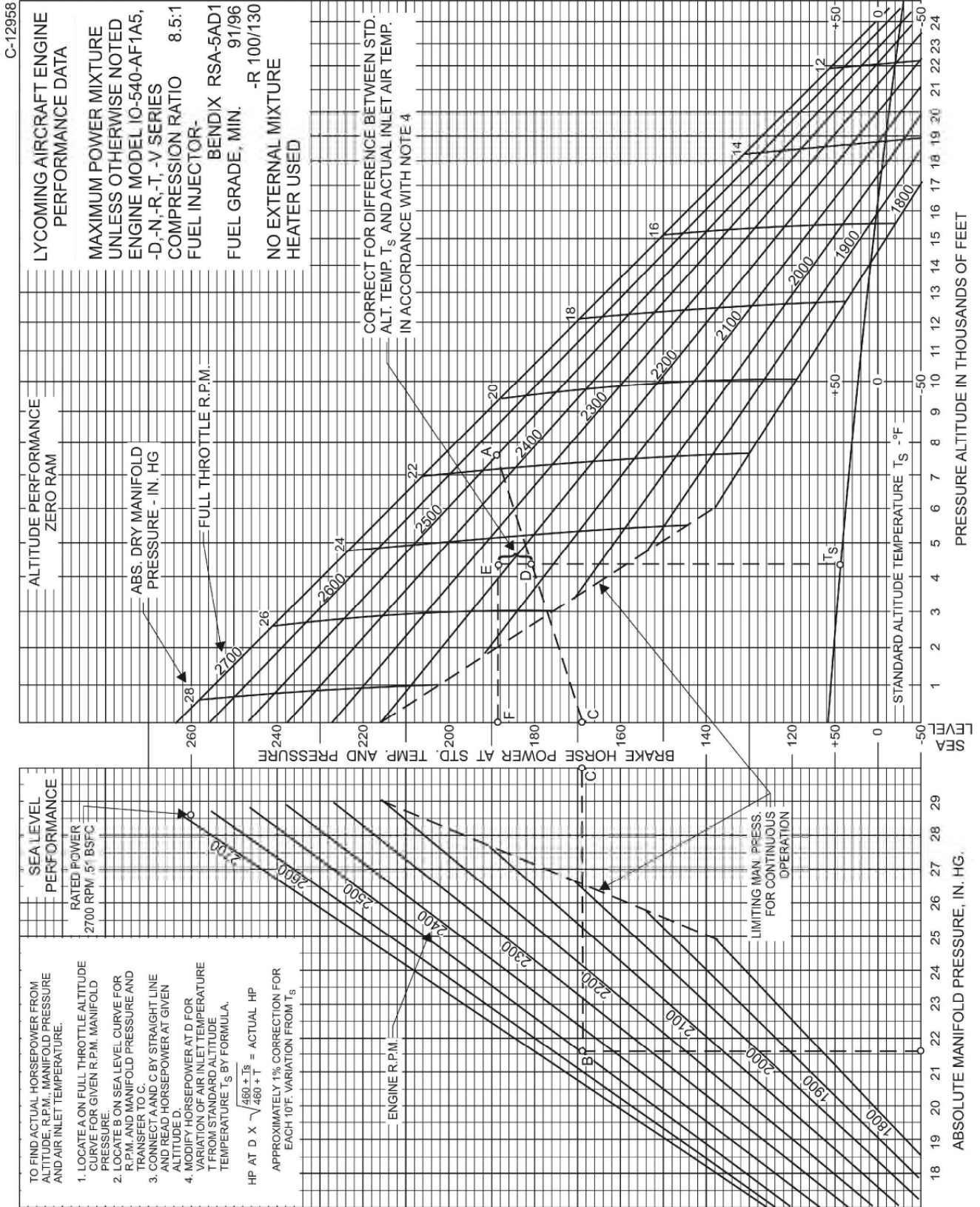

Figure 3-2. Sea Level and Altitude Performance Curve

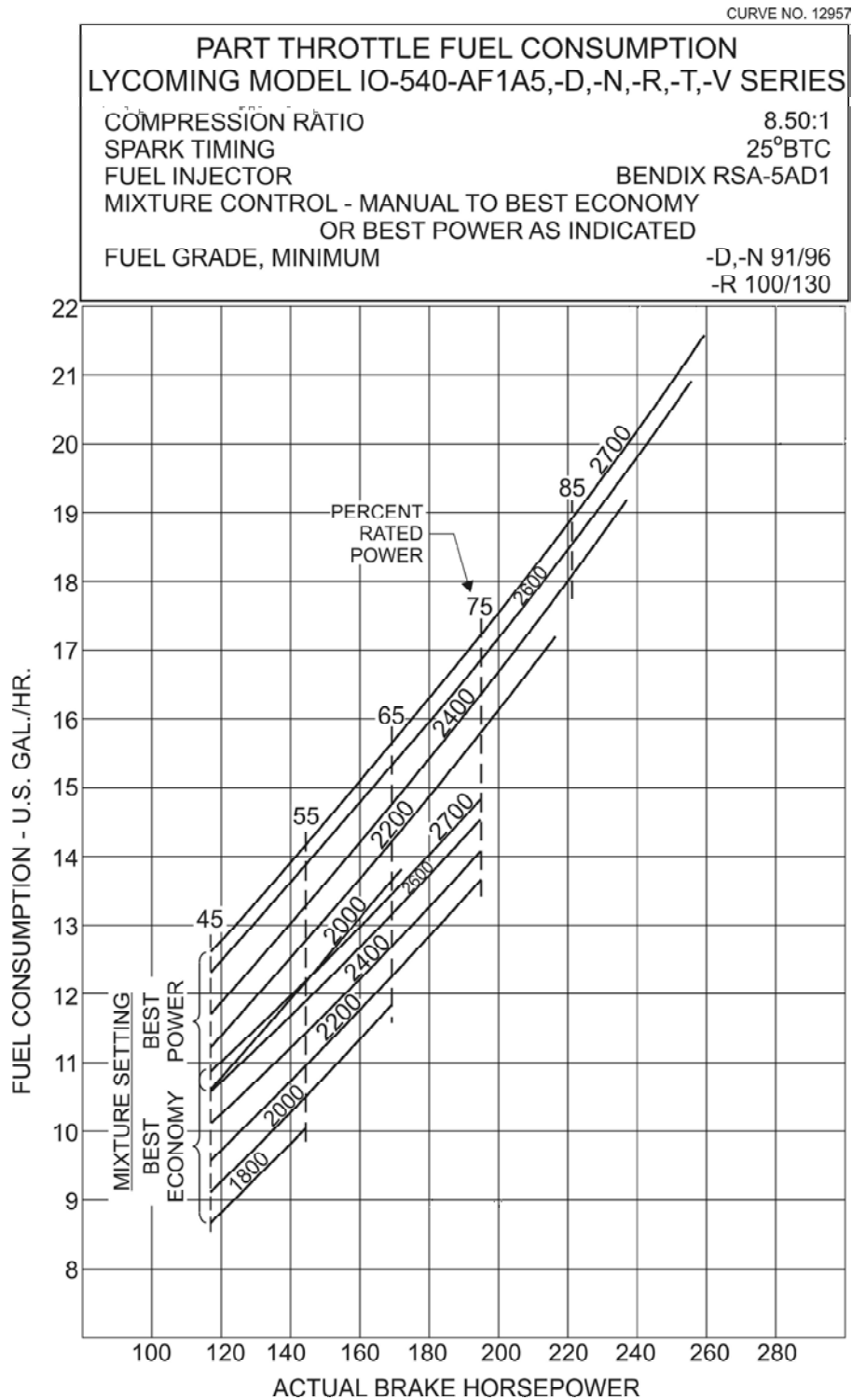

Figure 3-3. Minimum Fuel Flow vs. Power

This Page Intentionally Left Blank.

SECTION II
INSTALLATION

This Page Intentionally Left Blank

LYCOMING OPERATION AND INSTALLATION MANUAL

SECTION II

PART 1 PREPARATION

	Page
Preparation of Engine for Installation	II-1-1
Uncrating.....	II-1-1
Uninhibiting	II-1-1
Preparation of Fuel Injector.....	II-1-2

LYCOMING OPERATION AND INSTALLATION MANUAL

This Page Intentionally Left Blank.

SECTION II

PART 1
PREPARATION OF ENGINE FOR INSTALLATION

Each Lycoming engine undergoes a thorough preservative treatment before leaving the factory. To protect the cylinders and related parts, preservative oil is sprayed into each cylinder. Careful uncrating and uninhibiting of the engine is very important to prevent any of the preservative oil from entering the induction system.

1. *UNCRATING.*

The Lycoming IO-540-AF1A5 engine has been carefully packed for shipment to prevent damage in transit and to ensure that the engine reaches its destination in perfect condition.

NOTE

Any engine that has been stored in a cold area must be brought into an area with a temperature of at least 70°F (21°C) for 24 hours before uncrating. If this is not possible, the preservative oil in the engine must be warmed to facilitate draining by heating the cylinders with heat lamps.

- a. Remove the top of the crate and set it aside.
 - b. Lift and set aside any packing materials from on top of the engine.
 - c. Connect an engine lifting cable to a winch, hoist, or crane able to support a minimum load of 750 lbs.
 - d. Connect the engine lifting cable to the lifting lugs on the top of the engine.
 - e. Lift the engine from the crate.
2. *UNIHIBITING ENGINE.*



Do not rotate the crankshaft of an engine containing preservative oil before removing the bottom spark plugs. Engine damage will result.



Avoid contact of preservation oil with painted surfaces. If preservation oil does contact a painted surface, clean it off with a solvent as soon as possible.

- a. Remove all the bottom spark plugs.
- b. Turn the crankshaft three or four revolutions by hand.
- c. Tilt the engine to one side until the spark plug holes on that side are oriented vertically.

- d. Rotate the crankshaft at least two revolutions and allow the oil to drain out through the spark plug holes.
- e. Repeat steps (3) and (4) for the opposite side of the engine.
- f. Inspect the spark plugs before reinstalling them. If they are not clean, wash them in clean oil-based solvent. Dry them with compressed air.
- g. Remove the oil sump plug and allow any preservative oil that has accumulated in the sump to drain.
- h. Remove the oil screen and clean it with a hydrocarbon-based solvent such as Varsol or equivalent.
- i. Reinstall the oil screen.
- j. If a constant speed propeller is to be used, the expansion plug must be removed from the crankshaft. Pierce a 1/8 in. to 3/16 in. hole in the center of the plug to remove it.
- k. Replace the oil sump plug and install a safety wire. Refer to Maintenance and Overhaul Manual P/N LMO-IO-540-AF1A5 for lockwire information.
- l. Fill the sump with 8 quarts of aviation-grade oil. Refer to Section I, Part 2 for oil recommendations.
- m. Inspect the induction riser to ensure that it is clean and dry. If a significant amount of preservative oil is noted, clean, reinspect, and reinstall the intake pipes.

3. *PREPARATION OF FUEL INJECTOR.*

- a. Remove the fuel inlet strainer and clean it with a hydrocarbon-based solvent such as Varsol or equivalent.
- b. Inspect the fuel supply lines, fuel manifold, throttle body, and “bullet nose” venturi to ensure they are clean and dry.
- c. Reassemble the injector. Inject clean fuel into the fuel inlet connection with the fuel outlets uncapped until clean fuel flows from the outlets. Do not exceed 15 psi inlet pressure.



Dispose of used engine preservative and solvents in accordance with all applicable federal, state, and local environmental regulations.

NOTE

If a small amount of preservative oil remains in the engine, it will not be harmful; however, during the first oil change, the oil should be drained while the engine is hot. This will remove any residual preservative oil.

LYCOMING OPERATION AND INSTALLATION MANUAL

SECTION II

**PART 2
PROCEDURES**

	Page
Installing Engine	II-2-1
Connecting External Accessories	II-2-1
Pre-Oiling Engine Prior to Start	II-2-5

LYCOMING OPERATION AND INSTALLATION MANUAL

This Page Intentionally Left Blank.

SECTION II

PART 2

1. *INSTALLING ENGINE.*

- a. Refer to Figures 2-1 through 2-3 for dimensions and connection locations.
- b. If the engine is to be installed in an airframe from which an engine has previously been removed, inspect the engine mounts to ensure they are not bent, misaligned, distorted, or damaged.



Distorted, misaligned, bent, or damaged engine mounts may cause engine or airframe damage or engine failure.

- c. Refer to the airframe manufacturer's instructions for attaching the engine to the engine mounts.

2. *CONNECTING EXTERNAL ACCESSORIES.*

- a. Refer to installation drawing, Figure 2-3. Remove cover plate and gasket. When installing the accessory, use the gasket and hardware specified by the airframe manufacturer. Torque to the value specified for the thread size in the Table of Limits, IO-540-AF1A5 Maintenance and Overhaul Manual.
- b. Connect oil and fuel supply lines and any reporting devices, sensors, and senders per the airframe manufacturer's instructions. Refer to Figures 2-2 and 2-3 for connection locations.

Table 2-1.

Accessory	Location	Thread Size
Accessory Pad 1	Upper Right Side of Accessory Housing	1/4-20
Accessory Pad 2	Lower Right Side of Accessory Housing	1/4-20
Prop. Governor Pad	Upper Left Front of Crankcase	5/16-18

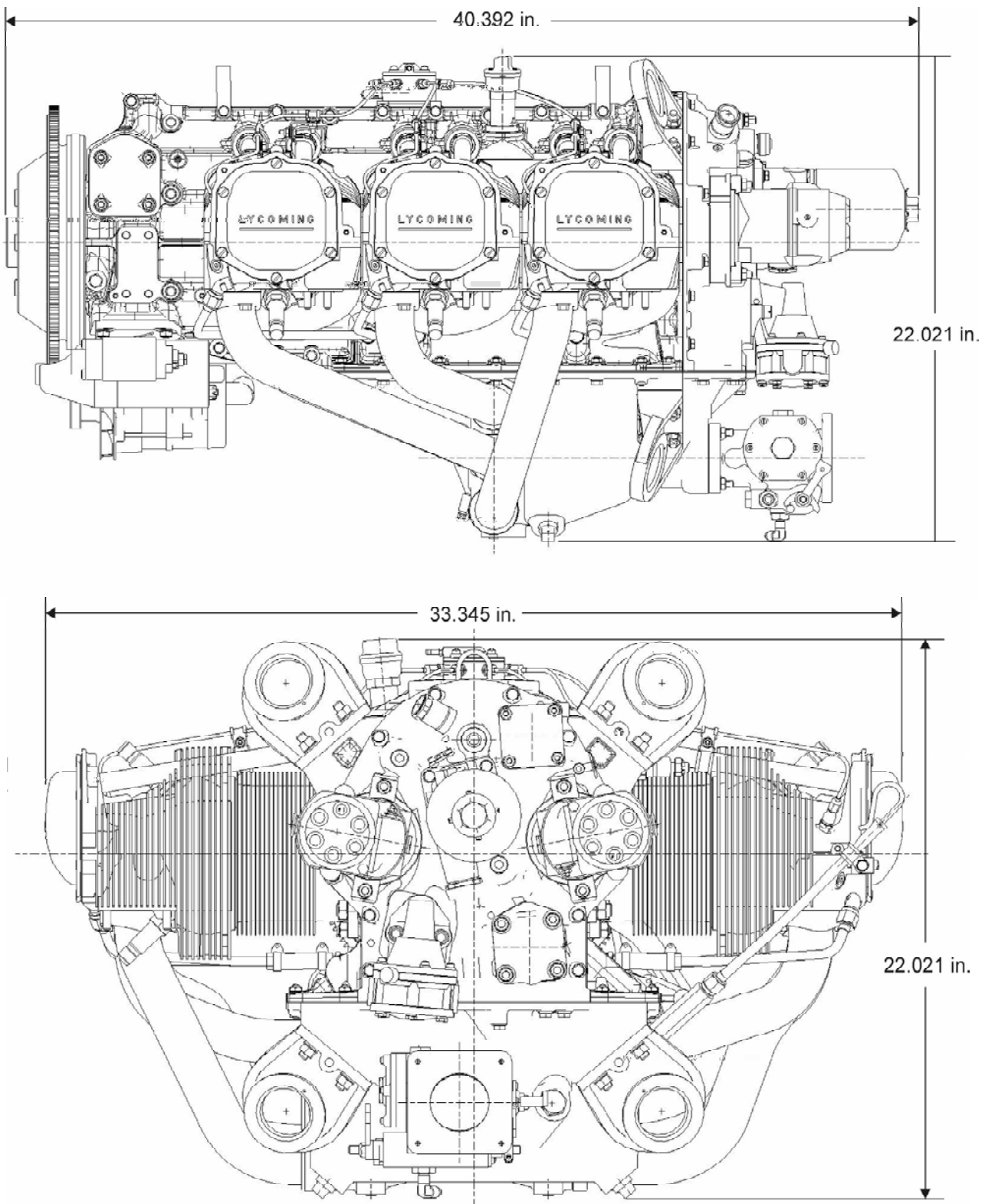

Figure 2-1. Dimensions

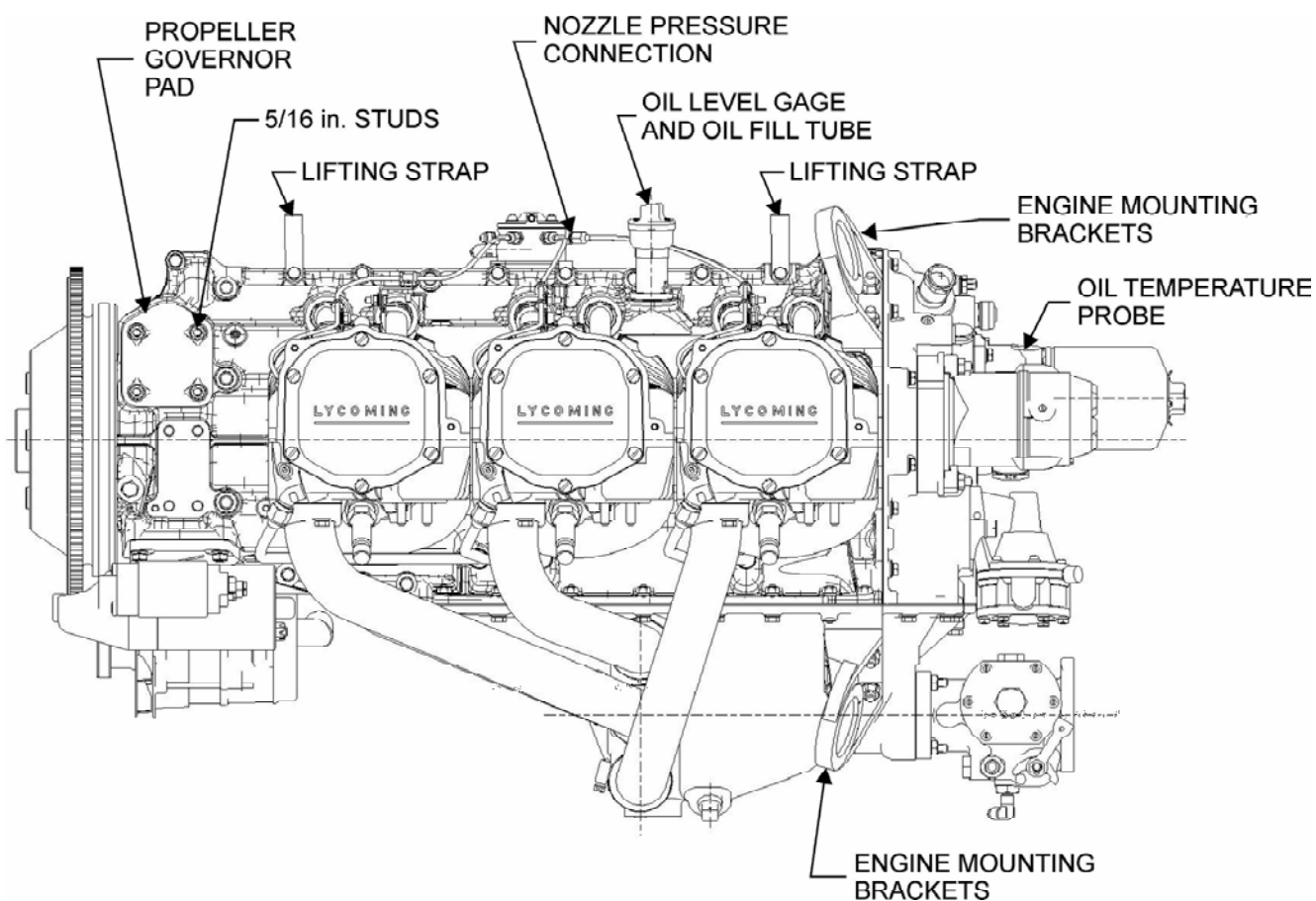

Figure 2-2. Installation, Left Side View

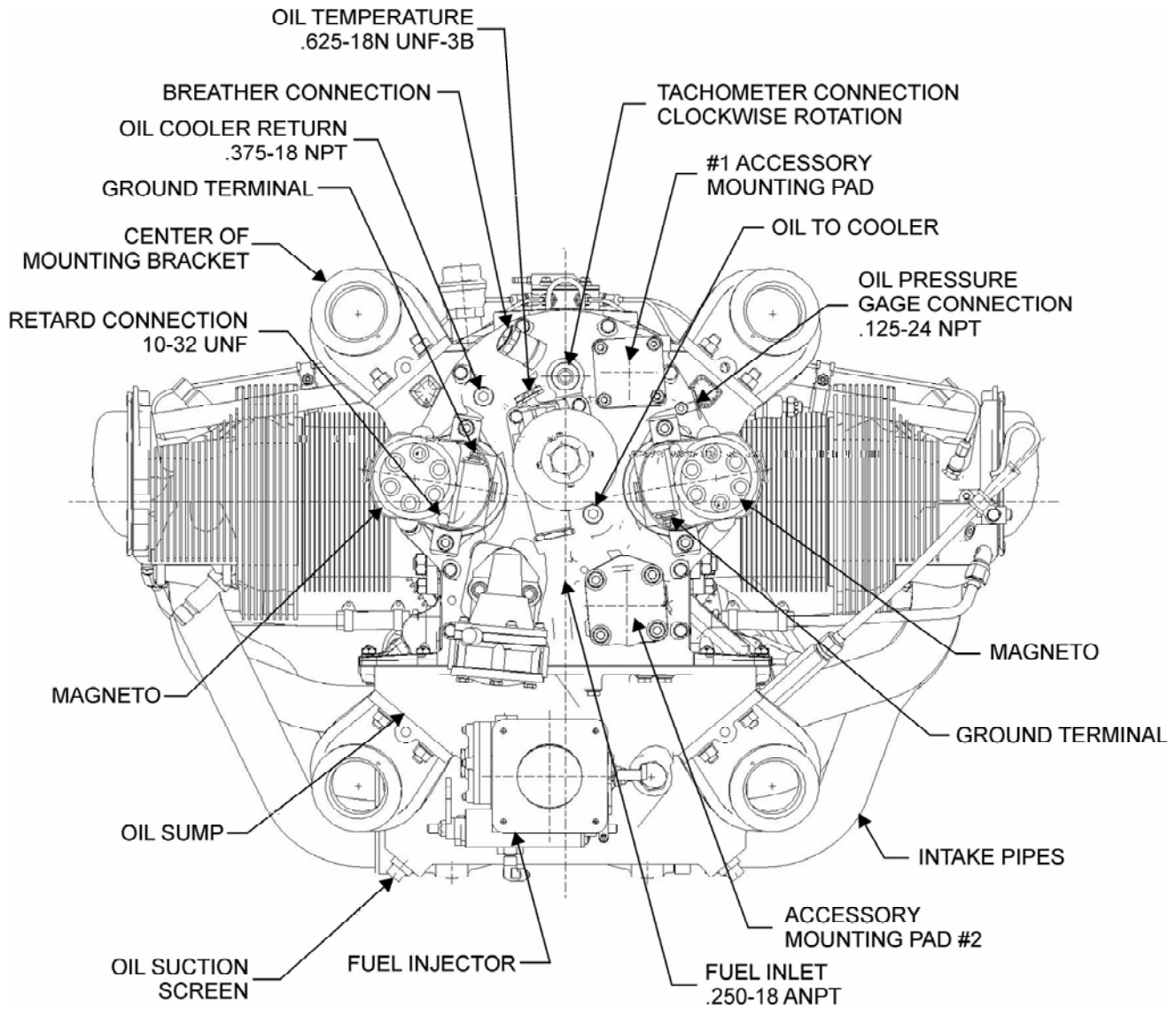

Figure 2-3. Installation, Rear View

3. PRE-OILING ENGINE PRIOR TO START.



To eliminate the possibility of high-speed bearing failure resulting from insufficient lubrication during initial starts, all aircraft engines must be pre-oiled after an overhaul, following oil cooler draining or replacement, or whenever the oil lines have been disconnected.



If a propeller is installed, remain clear of the propeller turning arc. The propeller will turn during this procedure, and could cause injury.

- a. Fill the oil cooler with oil.
- b. Remove one spark plug from each cylinder of the engine.
- c. If the aircraft is not equipped with an oil pressure gage, remove the STD-1102 allen plug from the upper left front of the main galley, aft of the propeller governor pad.
- d. Place the mixture control lever in the "IDLE CUT-OFF" position and the fuel selector switch in the "OFF" position.
- e. Turn the engine with the starter (or with an external power source, if available) until a minimum oil pressure of 20 lb. is indicated on the oil pressure gage or until there is a steady flow of oil from the opening on the engine.



Do not energize the starter for periods longer than 15 seconds. Allow the starter to cool after each energizing period. Refer to the starter manufacturer's instruction manual for additional information.

NOTE

If oil pressure is not determined after the first cranking of 10 to 15 seconds, allow the starter to cool and repeat the cranking/starter cooling sequence until 20 lb. is indicated on the oil pressure gage or oil flow is observed.



If there is no indication of steady oil pressure after five attempts, the cause should be determined and fixed.

**SECTION II
INSTALLATION**

**LYCOMING OPERATION AND INSTALLATION MANUAL
IO-540-AF1A5**

- f. Turn the starter for an additional 10 seconds to verify that the oil pressure remains at latest 20 lb.
- g. Reinstall the spark plugs and proceed with normal starting procedures immediately. Refer to Section I, Part 3.
- h. When the engine starts, observe the oil pressure gage. If there is no oil pressure indication, shut down the engine until cause is determined.
- i. Allow the engine to run for approximately 3 minutes at 1000 rpm.
- j. Shut down in accordance with Section I, Part 3, Step 10.